

**Wide Operating
Temperature**

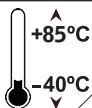

Em104-i230F R1.2

Wide Range Temperature PC/104 CPU Module

Quick Installation Guide

Version 1.2

Form Factor
<i>PC/104 CPU Module</i>

CPU
<i>Intel® Atom™ E3800 Family Processor</i>

Video
<i>Analog RGB/ Dual Channel 24-bit LVDS</i>

LAN
<i>2 x Intel i211AT PCIe GbE controllers</i>

I/O
<i>PC104 / USB / SATA/ COM</i>

◆ Technical Support

If you have any technical difficulties, please consult the user's manual first at:
<https://www.arbor-technology.com>

Contact our customer service at the following addresses if your problem persists.
<https://www.arbor-technology.com>
E-mail: info@arbor.com.tw

◆ Declaration of Conformity

FCC Class A

This device complies with Part 15 of the FCC Rules. Operation is subject to the following two conditions : (1) this device may not cause harmful interference, and (2) this device must accept any interference received, including interference that may cause undesired operation.

Copyright® All Rights Reserved.

CE 4041023002120P

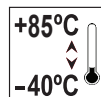

Packing List

Before you begin installing your single board, please make sure that the following materials have been shipped:



1 x Em104-i230F



1 x Heat Sink



1 x Quick Installation Guide

If any of the above items is damaged or missing, contact your vendor immediately.

Ordering Information

Em104-i230F-E3825	Intel® Atom™ Processor E3825 PC/104 WT CPU module
Em104-i230F-E3845	Intel® Atom™ Processor E3845 PC/104 WT CPU module

Optional Accessories

CBK-11-230F-00	<p>Cable kit</p> <ul style="list-style-type: none">• 1 x SATA cable• 1 x Audio cable• 4 x COM port cables• 1 x KB & MS Y-cable• 1 x USB cable• 1 x VGA cable• 2 x LAN cables
----------------	--

Specifications

System	
CPU	Soldered onboard Intel® Atom™ Processor E3825 dual-core 1.33GHz E3845 quad-core 1.91GHz
Memory	1 x DDR3L SO-DIMM socket, supporting up to 8GB 1333 MT/s SDRAM
BIOS	Insyde BIOS
Watchdog Timer	1 ~ 255 levels reset
I/O	
I/O Chipset	Fintek F81866
Serial Port	2 x RS-232
	2 x RS-232/422/485 selectable
USB Port	2 x USB 2.0 ports
	1 x USB 3.0 port
KB/MS	6-pin wafer connector for PS/2 keyboard and mouse via Y-cable
Expansion	PC/104 interface & Mini-card socket
Storage	1 x Serial ATA port with 300MB/s HDD transfer rate
	1 x mSATA socket (Socket shared and BIOS selectable with Mini PCIe card)
Ethernet Chipset	2 x Intel i211AT PCIe GbE controllers
Digital I/O	8-bit programmable
Audio	Realtek ALC888S HD Audio CODEC, Mic-in/ Line-in/Line-out
Display	
Graphics Chipset	Integrated Intel® HD Graphics
Graphics Interface	Analog RGB supports resolution up to 2048 x 1536
	LCD: Dual Channel 24-bit LVDS

Mechanical & Environmental	
Power Requirement	+5V (Additional +12V might be required for LCD panel)
Power Consumption	1.81A@5V with E3825 (Typical) 2.24A@5V with E3845 (Typical)
Operating Temp.	-40 ~ 85°C (-40 ~ 185°F)
Operating Humidity	10%~95% @ 85°C (non-condensing)
Dimension (L x W)	96 x 90 mm (3.8" x 3.5")

Driver Installation Notes

To install the drivers, please go to our website at www.arbor-technology.com and download the driver pack from the product page. Then extract the downloaded file and follow the sequence below to install the drivers:

Chipset → **Graphic** → **Audio** → **Other drivers**

Board Dimensions

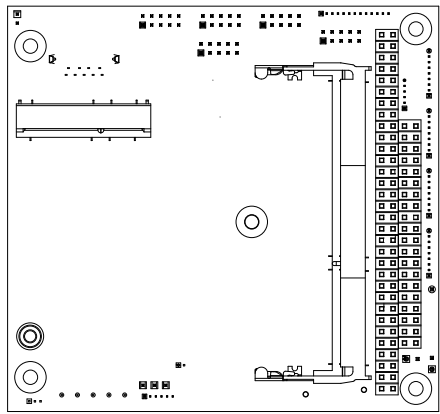
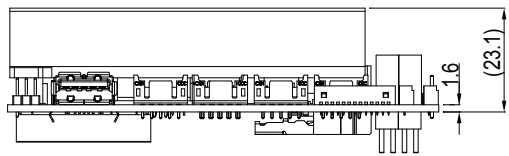
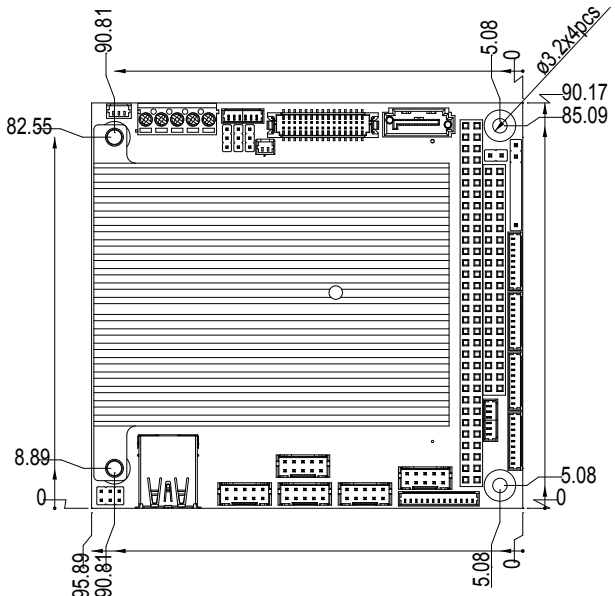

Unit:mm

The Installation of Heatsink

1. Prepare the heatsink included in standard accessory kit. Mount it on the CPU module as below. Overturn the card and tighten the central screw..

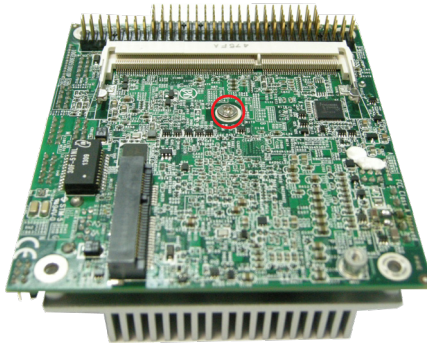
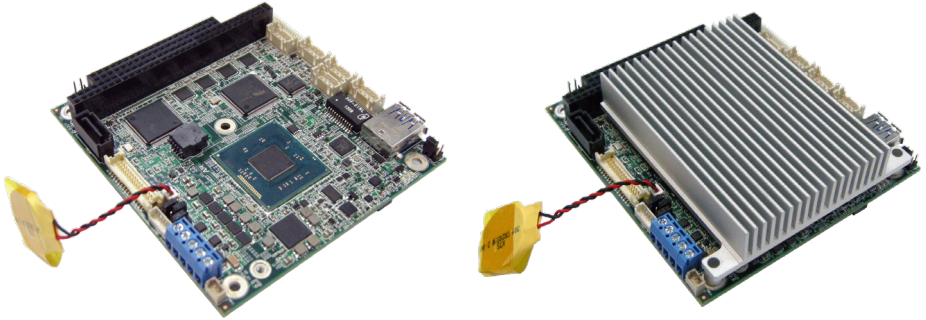

2. Insert screws into screw holes at corners. Secure nuts from another side to fix screws.

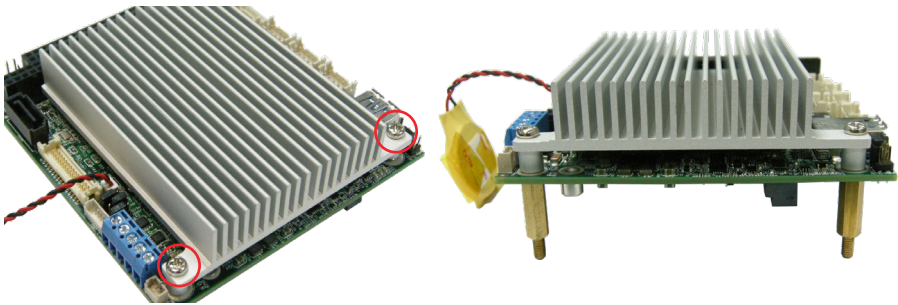

Jumpers & Connectors Quick Reference

Jumpers

Label	Function
JINV1	LCD Inverter Voltage Selection
JLVCD1	LCD Panel Voltage Selection
JBAT1	Clear CMOS Setting
JPIC1	Internal Testing

Connectors

Label	Function
USB1	USB 3.0/2.0 Connector
LAN1,2	Ethernet Connectors
USB2	USB 2.0 Connector
AUDIO1	AUDIO connector
VGA1	Analog RGB Display Connector
DIO1	DIO connector
KBMS1	Keyboard and Mouse Connector
CON1	PC/104 Connector
COM1~2	RS-232/422/485 Serial Ports
COM3~4	RS-232 Serial Ports
JFRT1	Front Panel connector
SATA1	Serial ATA Connector
LVDS1	LVDS Panel Connector
INV1	LCD Inverter Connector
PWR1	12V/5V Power Input
FAN1	Fan Connector
CON3	mSATA Full-Size Socket

Jumpers Location

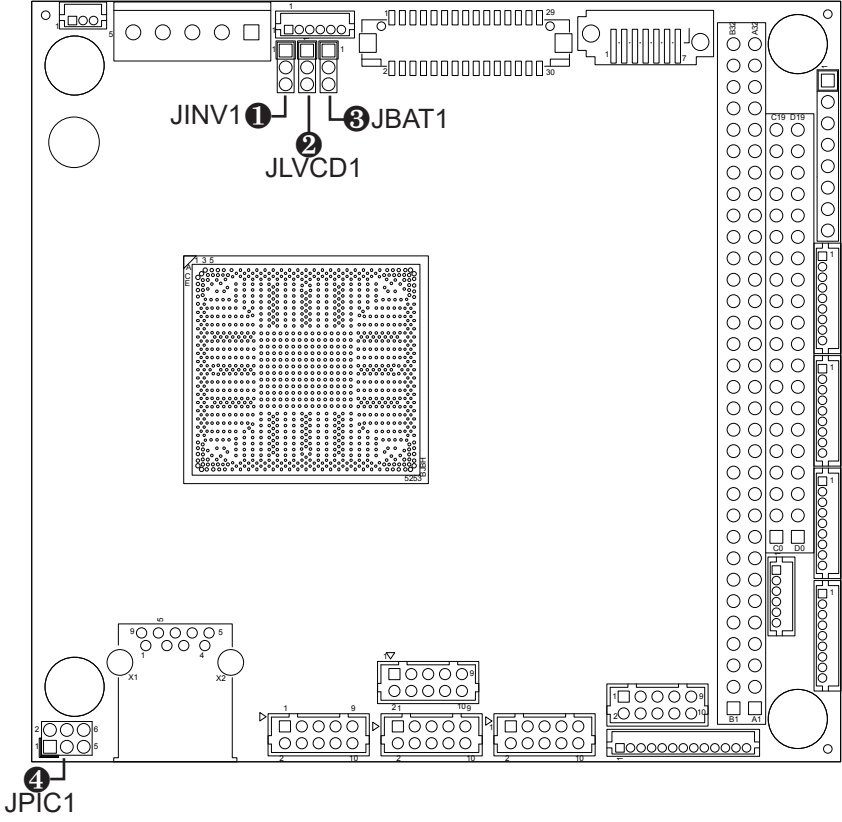

Connectors Location

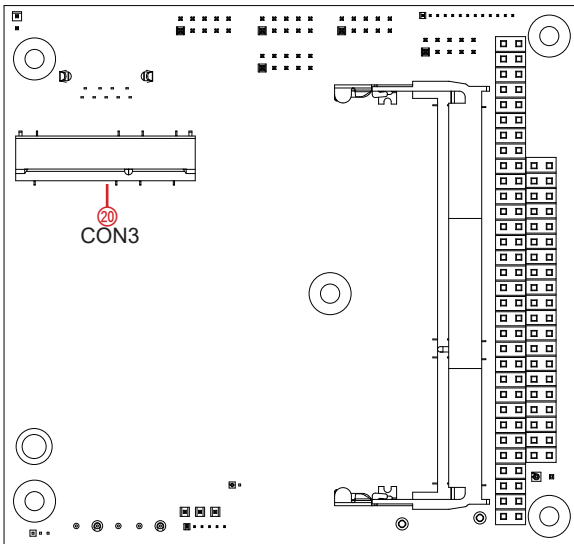
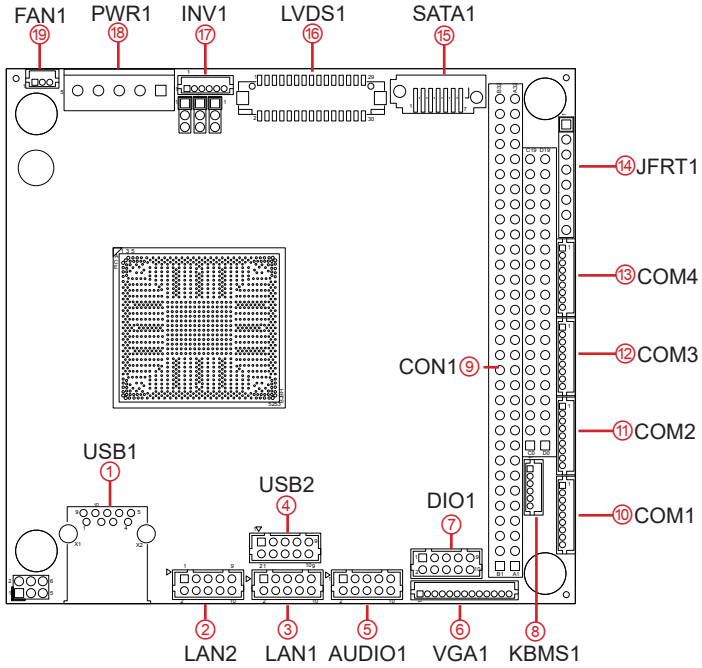

Jumpers

① JINV1: LCD Inverter Voltage Selection

Connector type: 2.00mm pitch, 1x3-pin header
The voltage of INV1 is selected by JINV1; that is to say, INV1's pin1 is defined by JINV1.

Pin	Description
-----	-------------

1-2	+12V
-----	------



2-3	+5V (default)
-----	---------------



② JLVCD1: LCD Panel Voltage Selection

Connector type: 2.00mm pitch, 1x3-pin header
The voltage of LCD panel is selected by JLVCD1.

Pin	Description
-----	-------------

1-2	+5V
-----	-----



2-3	+3.3V (default)
-----	-----------------



③ JBAT1: Clear CMOS Setting

Connector type: 2.00mm pitch, 1x3-pin header
The voltage of LCD panel is selected by JLVCD1.

Pin	Description
-----	-------------

1-2	Keeps CMOS (default)
-----	----------------------



2-3	Clears CMOS
-----	-------------



④ JPIC1: Internal Testing

This jumper is for internal testing only.

Connectors

① USB1: USB 3.0/2.0 Connector

Connector type: Type A connector

The pin assignments conform to the industry standard.



②③ LAN1~2: Ethernet Connectors

Connector type: 2.00mm pitch 2x5-pin wafer connector

Pin	Desc.	Pin	Desc.
2	TX_MDI0-	1	TX_MDI0+
4	MDI2+	3	RX_MDI1+
6	RX_MDI1-	5	MDI2-
8	MDI3-	7	MDI3+
10	N/C	9	N/C

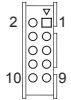

④ USB2: USB 2.0 Connector

Connector type: 2.00mm pitch 2x5-pin wafer connector

Pin	Desc.	Pin	Desc.
2	+5V-	1	+5V
4	USBP1-	3	USBP0-
6	USBP1+	5	USBP0+
8	GND	7	GND
10	N/C	9	GND



⑤ AUDIO1: AUDIO connector

Connector type: 2.00mm pitch 2x5-pin wafer connector

Pin	Desc.	Pin	Desc.
2	LINE-R	1	Line_L
4	GND3	3	GND1
6	N/C	5	MIC1
8	GND4	7	GND2
10	LOUT_R	9	LOUT_L

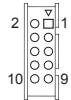

⑥VGA1: Analog RGB Display Connector

Connector type: 1x13-pin ACES 1.25mm 86801-13

4-wall connector

Pin Description

1	VGA_VSYNC
2	VGA_HSYNC
3	GND
4	SCL
5	SDA
6	GND
7	BLUE
8	GND
9	GREEN
10	GND
11	RED
12	GND
13	VCC



⑨CON1: PC/104 Connector

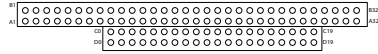

The pin assignments conform to the industry standard.

⑩⑪COM1~2: RS-232/422/485 Serial Ports

Connector type: 1x9-pin ACES 1.25mm 86801-09

4-wall connector

	RS-232	RS-422	RS-485
Pin	Desc.	Desc.	Desc.
1	DCD#	TX-	D-
2	DSR#		
3	RX	TX+	D+
4	RTS#		
5	TX	RX+	
6	CTS#		
7	DTR#	RX-	
8	RI#		
9	GND		



⑦DIO1: DIO Connector

Connector type: 2.00mm pitch 2x5-pin wafer connector

Pin	Desc.	Pin	Desc.
2	DIO1	1	DIO0
4	DIO3	3	DIO2
6	DIO5	5	DIO4
8	DIO7	7	DIO6
10	GND	9	5V

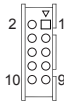

⑫⑬COM3~4: RS-232 Serial Ports

Connector type: 1x9-pin ACES 1.25mm 86801-09

4-wall connector

RS-232	
Pin	Desc.
1	DCD#
2	DSR#
3	RX
4	RTS#
5	TX
6	CTS#
7	DTR#
8	RI#
9	GND



⑧KBMS1: Keyboard & Mouse Connector

Connector type: 1x6-pin CVILUX 1.25mm

CI4406P1V00- LF 4-wall connector

Pin	Description
1	KB_DATA
2	KB_CLK
3	GND
4	PS2_VCC
5	MS_DATA
6	MS_CLK



⑭ JFRT1: Front Panel connector

Connector type: 2.54mm pitch 1x8-pin header

Pin	Description
1	RESET
2	GND
3	PWR LED+
4	GND
5	HDD LED+
6	HDD LED-
7	SPKOUT+
8	SPKOUT-

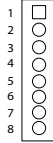

⑮ SATA1: Serial ATA Connector

High speed transfer rates (300MB/s).

Pin	Description
1	GND
2	TX+
3	TX-
4	GND
5	RX-
6	RX+
7	GND



⑯ LVDS1: LVDS Panel Connector

Connector type: DF-13-30DP-1.25V connector

Pin Description	Pin Description
2 VDD	1 VDD
4 TX2CLK+	3 TX1CLK+
6 TX2CLK-	5 TX1CLK-
8 GND	7 GND
10 TX2_D0+	9 TX1_D0+
12 TX2_D0-	11 TX1D0-
14 GND	13 GND
16 TX2_D1+	15 TX1D1+
18 TX2_D1-	17 TX1D1-
20 GND	19 GND
22 TX2D2+	21 TX1D2+
24 TX2D2-	23 TX1D2-
26 GND	25 GND
28 TX2D3+	27 TX1D3+
30 TX2D3-	29 TX1D3-



⑰ INV1: LCD Inverter Connector

Connector type: 1x6-pin CVILUX 1.25mm CI4406P1V00- LF 4-wall connector

Pin	Description
1	INV_VCC
2	INV_VCC
3	BKLT_EN
4	BKLT_CTRL
5	GND
6	GND



⑱ PWR1: 12V/5V Power Input

Connector type: 1x5-pin terminal

Pin	Description
1	VCC 12V
2	GND
3	GND
4	VCC 5V
5	VCC 5V



⑲ FAN1: FAN Connector

Connector type: 1.25mm pitch 1x3-pin wafer connector

Pin	Description
1	GND
2	5V
3	N/C



⑳ CON3: mSATA Full-Size Socket

The pin assignments conform to the industry standard. (Socket shared and BIOS selectable with Mini-card) For further configuration, please refer to the BIOS session, Mini PCI Express Support in 3.2.2. On Board Device Support on page 35 of manual

