

EmCORE-i2305

3.5" Compact Board Quick Installation Guide

Version 1.3

Form Factor <i>3.5" Compact Board</i>	CPU <i>Intel® Atom™ Processor E3800 family & Celeron® Processor N-Series</i>	Video <i>Dual Channel 24-bit LVDS, Analog RGB, Vertical HDMI</i>
I/O <i>SATA/ mSATA/ USB/ COM/ DIO/ I2C</i>	LAN <i>2 x Intel i21x PCIe GbE controllers</i>	Audio <i>Realtek HD Audio CODEC, MIC-in/ Line-out/ Line-in</i>

◆ Technical Support

If you have any technical difficulties, please consult the user's manual first at:
<http://www.arbor-technology.com>

Contact our customer service at the following addresses if your problem persists.
E-mail: info@arbor.com.tw

◆ Declaration of Conformity

FCC Class A

This device complies with Part 15 of the FCC Rules. Operation is subject to the following two conditions : (1) this device may not cause harmful interference, and (2) this device must accept any interference received, including interference that may cause undesired operation.

Packing List

Before starting with the installation, make sure the following items are shipped:



1 x EmCORE-i2305 3.5" Compact Board with heatsink



1 x Quick Installation Guide

If any of the aforelisted items is damaged or missing, contact your vendor immediately.

Ordering Information

EmCORE-i2305-E3825	Intel® Atom™ Processor E3825 3.5" Compact Board
EmCORE-i2305-WT-E3825	Wide range temperature Intel® Atom™ Processor E3825 3.5" Compact Board
EmCORE-i2305-E3845	Intel® Atom™ Processor E3845 3.5" Compact Board
EmCORE-i2305-WT-E3845	Wide range temperature Intel® Atom™ Processor E3845 3.5" Compact Board
EmCORE-i2305-N2807 (BTO)	Intel® Celeron® Processor N2807 3.5" Compact Board
EmCORE-i2305-N2930 (BTO)	Intel® Celeron® Processor N2930 3.5" Compact Board
CBK-07-2305-00	Cable kit 1 x AUDIO cable 2 x COM port latching cables 1 x Keyboard & mouse latching y-cable 1 x SATA cable 1 x SATA power cable 1 x USB cable

Driver (8.1A) installation

To install the drivers, please visit our website at www.arbor.technology.com and download the driver pack from the product page.

Windows 7

Device	Driver Path
Audio	\Win7\Audio\ALC886\9071_FF00_PG476_Win10_RS4_RS5_19H1_20H1_Win7_WHQL
Chipset	Win7\Chipset
Ethernet	\Win7\LAN\Install_Win7_7085_05222014
GPIO	Win7\Processor IO
Graphic	Win7\Graphic\32bit_36.15.0.1073 Win7\Graphic\64bit_37.15.0.1073
TXE	Win7\TXE Patch
USB3.0	Win7\USB3.0
Serial IO	Win7\Serial IO\Intel Processor IO Drivers_Win7_32bit_64bit_Gold_v2.0

Windows 10

Device	Driver Path
Audio	\Win10\Audio\ALC886\9071_FF00_PG476_Win10_RS4_RS5_19H1_20H1_Win7_WHQL
Chipset	Win10\Chipset\Win32_64_10.1.17
Ethernet	\Win10\LAN\RT8111-Install_Win10_10010_07252017
GPIO	Win10\GPIO I2C\windows10_32_64
Graphic	Win10\Graphic\Win32 Win10\Graphic\Win64
TXE	Win10\TXE\11.07
Serial IO	Win10\SerialIO_WIN10_64_30.100.1841.2

Board Dimensions (SKU-E3825)

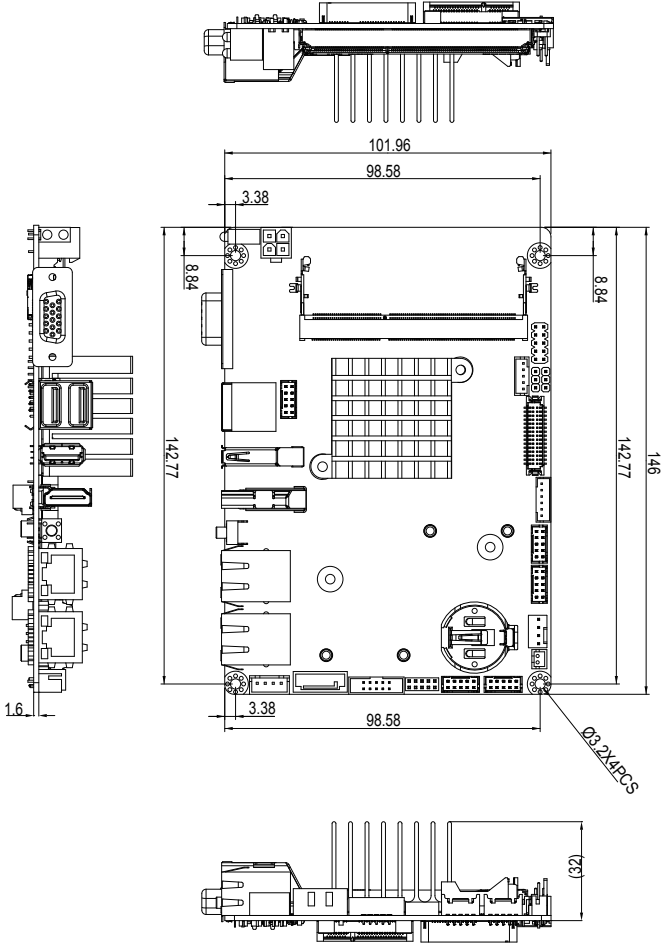

Unit: mm

Board Dimensions (SKU-E3845)

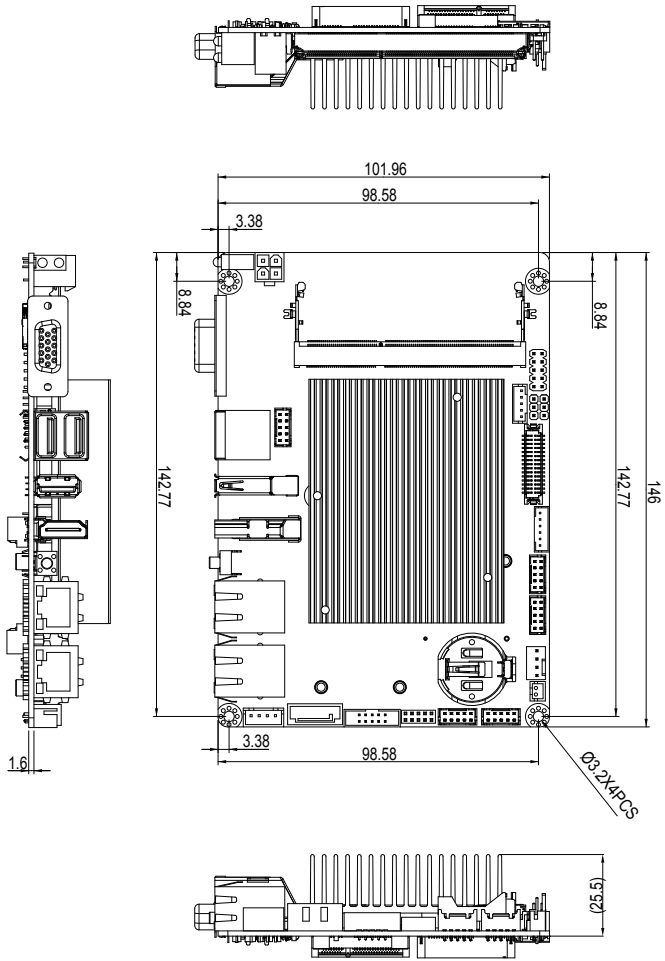

Unit: mm

Specifications

Form Factor	3.5" Compact Board	
CPU	Soldered onboard Intel® Atom™ Processor E3825 dual-core 1.33GHz, E3845 quad-core 1.91GHz, Celeron® N2807 dual-core 1.58GHz or N2930 quad-core 1.83GHz	
System Memory	1 x DDR3L SO-DIMM socket, supporting up to 8GB 1333/1600 MT/s SDRAM	
Graphics Chipset	Integrated Intel® HD Graphics	
Graphics Interface	HDMI	Vertical HDMI connector
	LCD	Dual-channel 24-bit LVDS
	Analog RGB that supports resolution up to 2048 x 1536	
Ethernet	2 x Intel i21x PCIe GbE controllers	
BIOS	Insyde BIOS	
Audio	Realtek® HD Audio CODEC, Mic-in/ Line-in/ Line-out	
Storage	1 x Serial ATA port with 300MB/s HDD transfer rate	
	1 x mSATA socket	
	Soldered onboard 16GB eMMC(optional) (E3800 Family Only)	
Serial Port	2 x COM ports (1 x RS-232 port, 1 x RS-232/485 port selectable)	
Universal Serial Bus	4 x USB 2.0 ports	
	1 x USB 3.0 port	
Digital I/O	8-bit programmable Digital Input/Ouput	
Expansion Bus	1 x Mini-card socket	
	1 x Micro-SDXC socket (E3800 family only, supports SDXC card SD 3.0 only)	
	2 x I ² C ports(optional) (E3800 Family Only)	
Power Requirement	+12V DC	
Power Consumption	0.56A@+12V (typical) (E3825) 0.65A@+12V (typical) (E3845)	
Operating Temp.	-20°C ~ 70°C (-4°F ~ 158°F) -40°C ~ 85°C (-40°F ~ 185°F, WT series)	
Operating Humidity	10% ~ 95% @ 70°C (non-condensing) 10% ~ 95% @ 85°C (non-condensing, WT series)	
Watchdog Timer	1~255 levels reset	
Dimension (L x W)	146 x 102 mm (5.7" x 4.0")	

Jumpers & Connectors Quick Reference

Jumpers

Jumper	Description
JPIC1	Sets the AT/ATX mode
JINV1	Sets the LCD inverter voltage
JVLCD1	Sets the power voltage for LVDS1 LCD.
JBAT1	Clears/keeps CMOS
JRS1	Sets the data transmitting signals for COM2 between RS-232, and RS-485.

Connectors

Connector	Description
INV1	LCD inverter connector
LVDS1	LVDS LCD panel connector
KBMS1	Keyboard & Mouse Connector
COM1&2	Serial port Connectors
FAN1	Fan Connector
CN1	RS-485 Connector
DIO1	Digital I/O Connector
I2C1	I2C connector
AUDIO1	Audio connector
SATA1	Serial ATA connector
PWROUT1	SATA power connector
LAN1,2	Gigabit Ethernet Connectors
RES1	Reset Button
HDMI1	HDMI Connector
USB2	USB 3.0 Connector
USB3	Double-stacked USB Connectors
USB1	USB 2.0 Connector
VGA1	Analog RGB Connector
12VIN1	ATX +12V Connectors
JFRT1	Provides connectors to front-panel status LED
SYSLED1	Power ON & HDD LED Indicator
MC1	Mini-card socket (on board bottom)
MSATA1	mSATA socket
SD1	Micro SDXC card socket

Jumper & Connector Locations

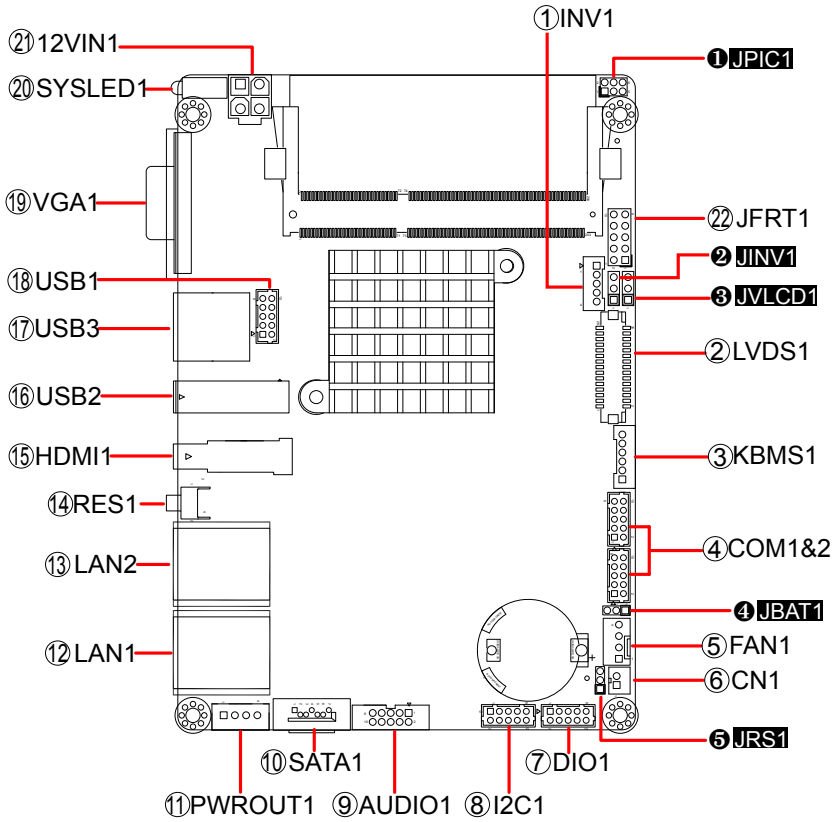

Board Bottom

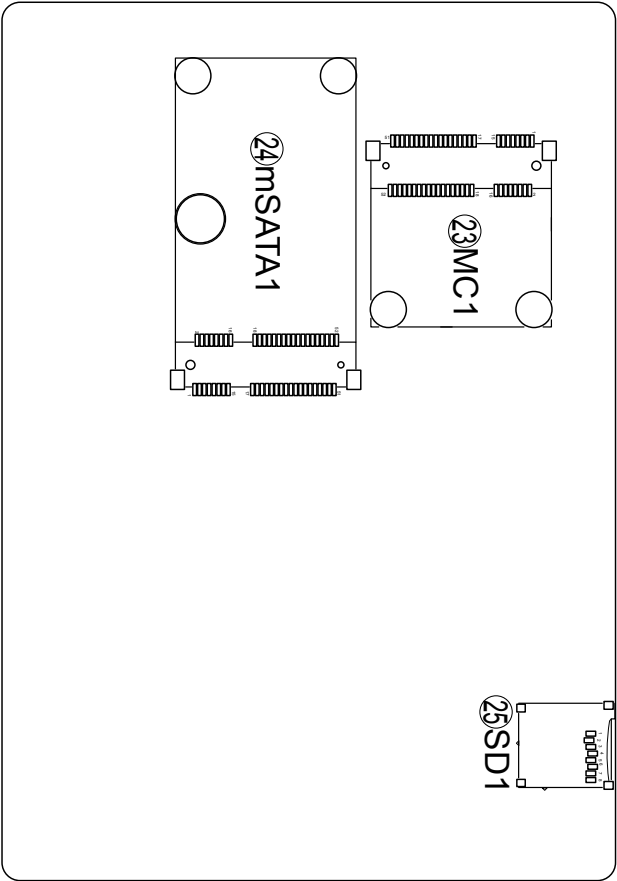



Jumpers

① JPIC1: Sets the AT/ATX mode

Jumper type: 2.00mm pitch 2x3-pin header



Pin	Description
2-4	AT
4-6	ATX (default)

② JINV1: Sets the LCD inverter voltage

Jumper type: 2.54mm pitch 1x3-pin header



Pin	Description
1-2	+12V
2-3	+5V (default)

③ JVLCD1: Sets the power voltage for LVDS1 LCD.

Jumper type: 2.54mm pitch 1x3-pin header



Pin	Description
1-2	+5V
2-3	+3.3V (default)

④ JBAT1: Clears/keeps CMOS

Jumper type: 2.00 mm pitch 1x3-pin header



Pin	Description
1-2	Keeps CMOS (default)
2-3	Clears CMOS

⑤ JRS1: COM2 RS-232/485 selection

Jumper type: 2.00 mm pitch 1x3-pin header

Pin	Description
1-2	RS-232 (default)
2-3	RS-485

Note: To enable RS-485 Port (CN1), beside jumper setting, please go to BIOS Setting Menu to Enable RS-485 mode of COM2. Option is under **Advanced/ SIO FINTEK71869E/ RS-232/485 Setting/ RS-485**. After enabled RS-485 Mode, CN1 will be activated as RS-485 port.

Connectors

① INV1: LCD inverter connector

Connector type: 2.00mm pitch 1x5-pin box wafer connector

Pin	Description
1	Vin
2	GND
3	on/off
4	Brightness control
5	GND



② LVDS1: LVDS LCD panel connector

Connector type: ACES 1.25mm 87209-3040-06 connector that supports 24-bit dual channels.

Pin	Description	Pin	Description
2	VDD	1	VDD
4	TX2_CLK+	3	TX1_CLK+
6	TX2_CLK-	5	TX1_CLK-
8	GND	7	GND
10	TX2_D0+	9	TX1_D0+
12	TX2_D0-	11	TX1_D0-
14	GND	13	GND
16	TX2_D1+	15	TX1_D1+
18	TX2_D1-	17	TX1_D1-
20	GND	19	GND
22	TX2_D2+	21	TX1_D2+
24	TX2_D2-	23	TX1_D2-
26	GND	25	GND
28	TX2_D3+	27	TX1_D3+
30	TX2_D3-	29	TX1_D3-

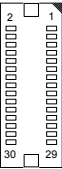

③ KBMS1: Keyboard & Mouse connector

Connector type: 2.0mm pitch 1x6-pin header

Pin	Description
1	KB_DATA
2	GND
3	MS_DATA
4	KB_CLK
5	PS2_VCC
6	MS_CLK



④ COM1&2: Serial port connector

Connector type: 2.00mm pitch 2x5-pin wafer connector

Pin	Description	Pin	Description
2	RX	1	DCD#
4	DTR#	3	TXD
6	DSR#	5	GND
8	CTS#	7	RTS#
10	N/C	9	RI#

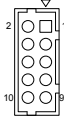

⑤ FAN1: Fan connector

Connector type: 2.54mm pitch 1x4-pin wafer connector.

Pin	Description
1	GND
2	+12V
3	Fan_Detect
4	Control



⑥ CN1: RS-485 connector

Connector type: 2.00mm pitch 1x2-pin Box Wafer Connector

Pin	Description
1	DATA -
2	DATA +



Note: To enable this port, please refer to Jumper Setting: JRS1 on P.10.

⑦ DIO1: Digital I/O connector

Connector type: 2.00mm pitch 2x5-pin wafer connector

Pin	Description	Pin	Description
2	GPIO1	1	GPIO0
4	GPIO3	3	GPIO2
6	GPIO5	5	GPIO4
8	GPIO7	7	GPIO6
10	GND	9	+5V

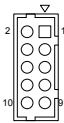

⑧ I2C1: I2C connector (E3800 Family Only)

Connector type: 2.00mm pitch 2x5-pin wafer connector

Pin	Description	Pin	Description
2	+3.3V	1	+3.3V
4	I2C_CLK1(3.3V)	3	I2C_CLK0(3.3V)
6	I2C_DATA1(3.3V)	5	I2C_DATA0(3.3V)
8	GND	7	GND
10	GND	9	GND

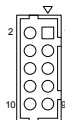

⑨ AUDIO1: Audio connector

Connector type: 2.00mm pitch 2x5-pin headers

Pin	Description	Pin	Description
1	Line Left In	2	Line Right In
3	GND	4	GND
5	MIC1	6	MIC2
7	GND	8	GND
9	Line-out Left	10	Line-out Right

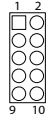

⑩ SATA1: Serial ATA connector

Connector type: SATA connector

The pin assignments conform to the industry standard.



⑪ PWROUT1: SATA power connector

Connector type: 2.54mm pitch 1x4-pin wafer connector

Pin	Description
1	VCC 5V
2	GND
3	GND
4	VCC 12V



⑫⑬ LAN1,2: Ethernet connectors

Connector type: RJ-45 connector that supports 10/100/1000Mbps fast Ethernet

Pin	Description	Pin	Description
1	MDIO+	2	MDIO-
3	MDI1+	4	MDI1-
5	MDI2+	6	MDI2-
7	MDI3+	8	MDI3-

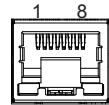

⑭ RES1: Reset Button

⑮ HDMI1: HDMI connector

Connector Type: 19-pin HDMI connector with flange

The pin assignments conform to the industry standard.

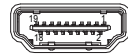

⑩ USB2: USB 3.0 connector

Connector type: USB 3.0/2.0 type-A connectors

The pin assignments conform to the industry standard.



⑪ USB3: Double-stacked USB connectors

Connector type: Two USB 2.0/1.0 type-A connectors

The pin assignments conform to the industry standard.

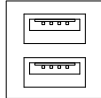

⑫ USB1: USB 2.0 connector

Connector type: 2.00mm pitch 2x5-pin wafer connector

Pin Description	Pin Description
2 +5V-	1 +5V
4 USBP1-	3 USBP0-
6 USBP1+	5 USBP0+
8 GND	7 GND
10 N/C	9 GND

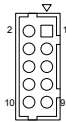

⑬ VGA1: Analog RGB connector

Connector type: D-Sub 15-pin female connector

Pin	Desc.	Pin	Desc.
1	RED	9	N/C
2	GREEN	10	GND
3	BLUE	11	N/C
4	N/C	12	D-DATA
5	GND	13	H-SYNC
6	GND	14	V-SYNC
7	GND	15	D-DCLK
8	GND		

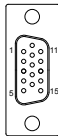

⑭ SYSLED1: Power ON & HDD LED Indicator

⑮ 12VIN1: Supplies ATX +12V

Connector type: 4-pin power connector

Pin Description	Pin Description
2 GND	4 +12V
1 GND	3 +12V

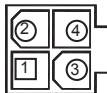

⑯ JFRT1: Provides connectors to front-panel status LED and toggles.

Connector type: 2.54mm pitch 2x5-pin header

Pin Description	Pin Description
1 RESET+	2 RESET-
3 PLED+	4 PLED-
5 HLED+	6 HLED-
7 SPEAK+	8 SPEAK-
9 PS0N+	10 PS0N-

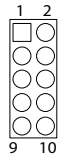

⑰ MC1: Mini-card socket

Connector type: Onboard 0.8mm-pitch 52-pin edge card connector interconnected with SIM card socket

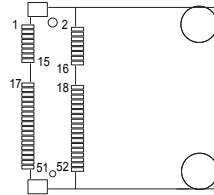

⑱ MSATA1: mSATA socket

Connector type: Onboard 0.8mm pitch 52-pin edge card connector

The pin assignments conform to the industry standard.

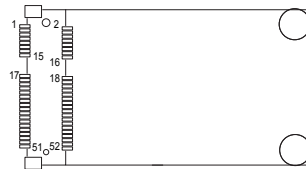

⑲ SD1: micro SDXC card socket (E3800 family only, supports SDXC card SD 3.0 only)

The pin assignments conform to the industry standard.

