

Wide Operating Temperature

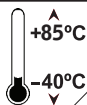

PBE-1101

Quick Installation Guide

Version 1.0

Form Factor <i>ETX Carrier Board</i>	VGA <i>LVDS, Analog RGB</i>	LAN <i>1 x LAN port by CPU module 1 x GbE port</i>
Audio <i>MIC-in/ Line-in/ Line-out</i>	I/O <i>PC104-Plus/ USB/ IDE/ COM/ LPT/ DIO/ CF II/ I2C/ IrDA/ PS/2</i>	

◆ Technical Support

If you have any technical difficulties, please consult the user's manual first at:
<ftp://ftp.arbor.com.tw/pub/manual>

Please do not hesitate to call or e-mail our customer service when you still can not find out the answer.

<http://www.arbor.com.tw>

E-mail: info@arbor.com.tw

Declaration of Conformity

FCC Class A

This device complies with Part 15 of the FCC Rules. Operation is subject to the following two conditions : (1) this device may not cause harmful interference, and (2) this device must accept any interference received, including interference that may cause undesired operation.

Copyright® All Rights Reserved.

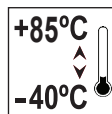

4041110100100P

Packing List

Before you begin installing your single board, please make sure that the following materials have been shipped:



GUIDE

- 1 x PBE-1101 ETX 3.02 Carrier Board
- 1 x Quick Installation Guide

Ordering Information

PBE-1101	ETX 3.02 Carrier Board
----------	------------------------

Optional Accessories

CBK-15-1101-00	<ul style="list-style-type: none">Cable kit1 x Audio cable2 x USB cables2 x Serial port cables1 x IDE cable1 x LPT cable2 x Ethernet cables1 x VGA cable1 x KB/MS cable2 x SATA cables1 x Power cable (4 wires)1 x Power cable (2 wires)
----------------	---

Specifications

I/O	
Serial Port	3 x RS-232 port with pin-header 1 x RS-232/422/485 selectable port with pin-header
Parallel Port	1 x LPT port
Keyboard & Mouse	1 x box header (PS/2 interface for keyboard and mouse)
USB 2.0	4 x USB 2.0 port w/ pin header
Expansion	PC/104-Plus interface 1 x I2C
Storage	1 x IDE box header 1 x CompactFlash Type II socket
Ethernet	1 x LAN port by CPU module 1 x GbE port
Digital I/O	16-bit Digital Input/Output, 8-in/ 8-out
Audio	Mic-in/Line-in/Line-out
RF	1 x IrDA
Display	
Graphic Interface	1 x VGA port
	1 x Dual channels 24-bit LVDS port
OS Support	
Depends on CPU module	
Mechanical & Environmental	
Power Requirement	+12V DC input
Power Consumption	1.789A@5V with EmETX-i2304-E3825 2.025A@5V with EmETX-i2304-E3845
Operating Temp.	-40 ~ 85°C (-40 ~ 185°F)
Operating Humidity	10 ~ 95% @ 85°C (non-condensing)
Dimensions (L x W)	114 x 95mm(4.48" x 3.7")

Block Diagram

PBE-1101 ETX Carrier Board

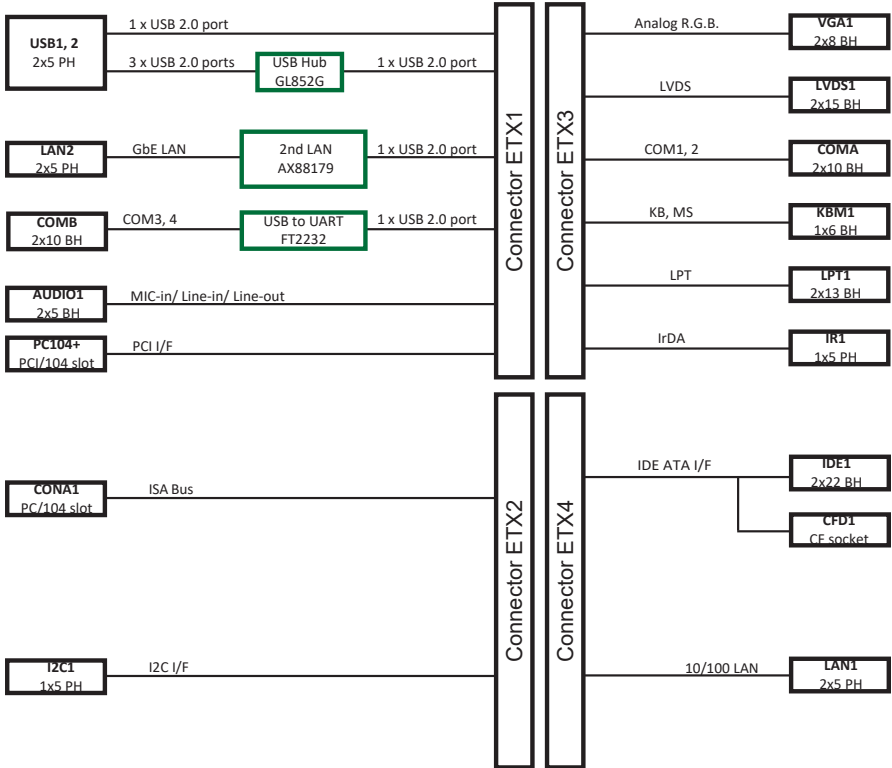

Board Dimensions

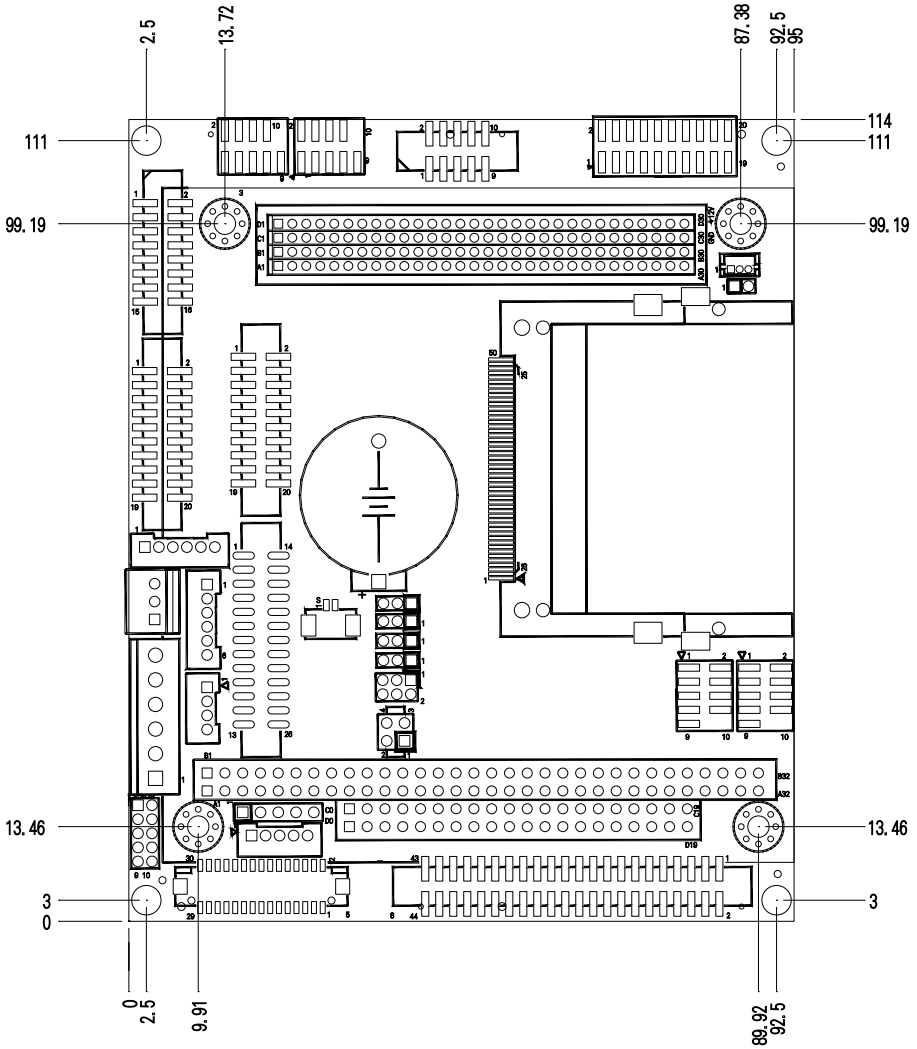

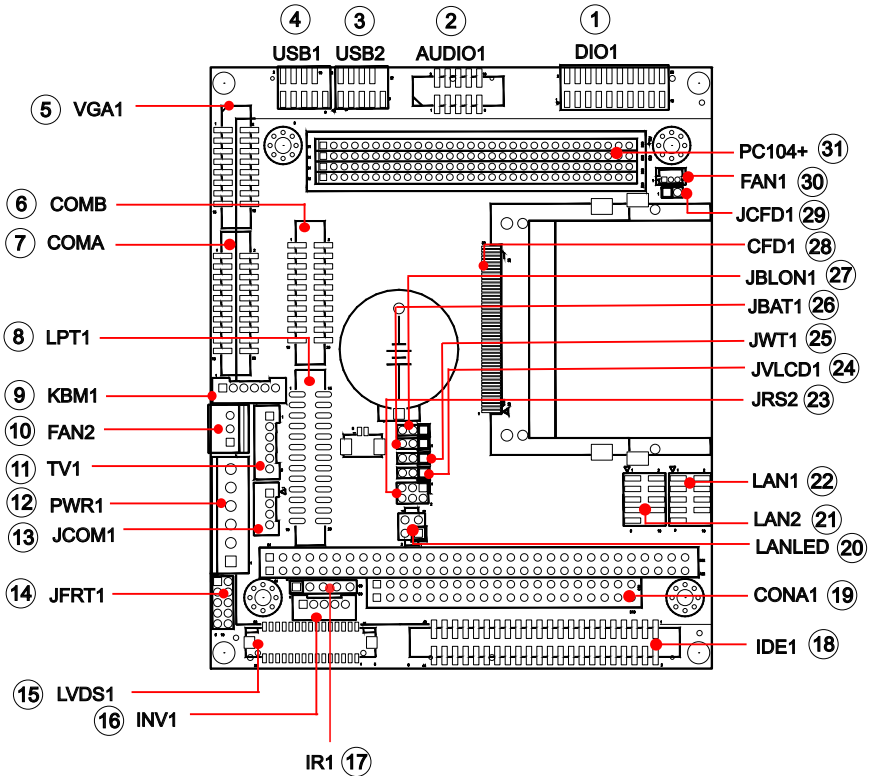

Connectors Quick Reference



Jumpers

JCFD1: CF IDE1 mode Selection (29)



Connector type: 2.00mm pitch 1x2-pin headers.

Pin	Mode	
Short	Master	 2
Open	Slave (Default)	 2

JBLON1: LCD Backlight Selection (27)



The LCD panel backlight active mode could be selected by JBLON1 in High or Low.

Connector type: 2.00mm pitch 1x3-pin headers.

Pin	Mode	
1-2	Active High (Default)	 3 2 1
2-3	Active Low	 3 2 1



JBAT1: Clear CMOS Setting (26)

Connector type: 2.00mm pitch 1x3-pin headers.

Pin	Mode	
1-2	Keep CMOS (Default)	 3 2 1
2-3	Clear CMOS	 3 2 1

JWT1: WDT Mode Setting (25)

Connector type: 2.00mm pitch 1x3-pin headers.



Pin	Mode	
1-2	NMI	 3 2 1
2-3	RST_SW (Default)	 3 2 1

None Disable WatchDog Timer

JVLCD1: LCD Panel Voltage Selection (24)

The voltage of LCD panel could be selected by JVLCD1 in +5V or +3.3V.

Connector type: 2.00mm pitch 1x3-pin headers.

Pin	Voltage	
1-2	+5V	 3 2 1
2-3	+3.3V (Default)	 3 2 1

JRS2: COM2 RS-232/422/485 Selection (23)

It can be configured COM2 to operate in RS-232, RS-422 or RS-485 mode.

Connector type: 2.00mm pitch 2x3-pin headers.

Mode	RS-232 (Default)	RS-422	RS-485
1-2	ON	OFF	OFF
3-4	ON	ON	OFF
5-6	OFF	ON	ON



Connectors

DIO1: Digital I/O Connector (1)

DIO1 supports 8-bit In/ 8-bit Out.

Connector type: 2.00mm pitch 2x10-pin headers

Pin Description Pin Description

1	DO0	2	DO1
3	DO2	4	DO3
5	DO4	6	DO5
7	DO6	8	DO7
9	GND	10	GND
11	DI0	12	DI1
13	DI2	14	DI3
15	DI4	16	DI5
17	DI6	18	DI7
19	+5V	20	+12V

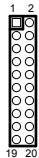

AUDIO1: AC97 Connector (2)

Connector type: 2.00mm pitch 2x5 box headers.

Pin Desc. Pin Desc.

1	Line_In_Left	2	Line_In_Right
3	GND	4	GND
5	MIC	6	N/C
7	GND	8	GND
9	Speaker Left	10	Speaker Right



USB1 ~ 2: USB Connectors (4, 3)

Connector type: 2.00mm pitch 2x5-pin headers.

Pin Desc. Pin Desc.

1	+5V	2	+5V
3	USB D-	4	USB D-
5	USB D+	6	USB D+
7	GND	8	GND
9	GND	10	N/C (Key)



VGA1: Analog RGB Connector (5)

Connector type: 2.00mm pitch 2x8-pin box headers.

Pin Description Pin Description

1	RED	2	GREEN
3	BLUE	4	N/C
5	GND	6	GND
7	GND	8	GND
9	N/C	10	GND
11	N/C	12	VDDAT
13	HSYNC	14	VSYNC
15	VDCLK	16	N/C

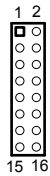

KBM1: Keyboard & Mouse Connector (9)

Connector type: 2.0mm pitch 1x6-pin box wafer connector.

Pin Description

1	KB_DATA
2	GND
3	MS_DATA
4	KB_CLK
5	KB_VCC
6	MS_CLK

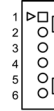

COM A~B: RS-232 Connectors (6, 7)

Connector type: 2.00mm pitch 2x10-pin box headers.

Pin Description Pin Description

1	DCD#1 / 3	2	RXD1 / 3
3	TXD1 / 3	4	DTR#1 / 3
5	GND	6	DSR#1 / 3
7	RTS#1 / 3	8	CTS#1 / 3
9	RI#1 / 3	10	N/C
11	DCD#2/ 4	12	RXD2/ 4
13	TXD2/ 4	14	DTR#2/ 4
15	GND	16	DSR#2/ 4
17	RTS#2/ 4	18	CTS#2/ 4
19	RI#2/ 4	20	N/C

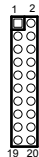

FAN2: Fan Power Connector (10)

FAN2 is a 3-pin headers for the fan. The fan must be a +12V fan.

Pin Description

1	GND
2	+12V
3	N/C



LPT1: Parallel Port Connector (8)

Connector type: 2.00mm pitch 2x13-pin box headers.

Pin Description Pin Description

1	STROBE#	14	AFD#
2	PTD0	15	Error#
3	PTD1	16	INIT#
4	PTD2	17	SLIN#
5	PTD3	18	GND
6	PTD4	19	GND
7	PTD5	20	GND
8	PTD6	21	GND
9	PTD7	22	GND
10	ACK#	23	GND
11	Busy	24	GND
12	PE	25	GND
13	Select	26	N/C

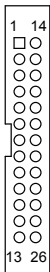

TV1: TV-out Connector (11)

Connector type: 2.00mm pitch 1x6-pin box wafer connector

Composite Video

1	CVBS	2	GND
3	Unused	4	GND
5	Unused	6	GND

S-Video

1	Unused	2	GND
3	Luminance	4	GND
5	Chrominance	6	GND

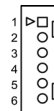

PWR1: Power Supply Connector (12)

Connector type: Terminal blocks.

Pin	Description
1	+12V
2	GND
3	GND
4	GND
5	+5V
6	+5V

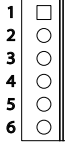

LVDS1: LVDS LCD Connector (15)

The LVDS connector on board 30-pin headers and supports 18/36-bit

Pin	Desc.	Pin	Desc.
2	VDD	1	VDD
4	TX2CLK+ 3	TX1CLK+	
6	TX2CLK- 5	TX1CLK-	
8	GND	7	GND
10	TX2D0+ 9	TX1D0+	
12	TX2D0- 11	TX1D0-	
14	GND	13	GND
16	TX2D1+ 15	TX1D1+	
18	TX2D1- 17	TX1D1-	
20	GND	19	GND
22	TX2D2+ 21	TX1D2+	
24	TX2D2- 23	TX1D2-	
26	GND	25	GND
28	TX2D3+ 27	TX1D3+	
30	TX2D3- 29	TX1D3-	



JCOM1: RS-422/485 Connector (13)

Connector type: 2.00mm pitch 1x4 box wafer connector.

Pin	RS-422	RS-485
1	TX+	DATA+
2	TX-	DATA-
3	RX+	N/C
4	RX-	N/C



JFRT1: Switches and Indicators (14)

It provides connectors for system indicators that provides light indication of the computer activities and switches to change the computer status.

Connector type: 2.00mm pitch 2x5-pin headers.

Pin	Description	Pin	Description
1	RESET+	2	GND
3	POWER_LED+	4	POWER_LED-
5	HDD_LED+	6	HDD_LED-
7	SPEAKER+	8	SPEAKER-
9	None	10	GND



INV1: LCD Inverter Connector (16)

Connector type: 2.00mm pitch 1x5-pin box wafer connector.

Pin	Description
1	+12V
2	GND
3	Backlight on/off
4	Brightness control
5	GND



IR1: Infrared Connector (17)

Connector type: 2.54mm pitch 1x5-pin headers.

Pin Description

1	+5V
2	N/C
3	IRRX
4	GND
5	IRTX



LANLED: LAN LED Indicators (20)

Connector type: 2.54mm pitch 2x2-pin headers

Pin Description

1-2	-ACTLED
3-4	-LILED



IDE1: Primary IDE Connector (18)

Connector type: 2.00mm pitch 2x22-pin box headers

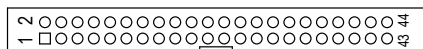

Pin Description

Pin	Description	Pin	Description
1	RESET#	2	GND
3	DATA7	4	DATA8
5	DATA6	6	DATA9
7	DATA5	8	DATA10
9	DATA4	10	DATA11
11	DATA3	12	DATA12
13	DATA2	14	DATA13
15	DATA1	16	DATA14
17	DATA0	18	DATA15
19	GND	20	N/C
21	DREQ	22	GND
23	IOW#	24	GND
25	IOR#	26	GND
27	IRDY	28	IDSEL
29	ACK#	30	GND
31	IRQ	32	N/C
33	AD1	34	ATA66 DETECT
35	AD0	36	AD2
37	CS#2	38	CS#3
39	ACT#	40	GND
41	+5V	42	+5V
43	GND	44	GND

LAN1~2: Ethernet Connectors (21, 22)

Connector type: 2.00mm pitch 2x5-pin headers

Pin Desc.

Pin	Desc.	Pin	Desc.
1	TX_MDIO+	2	TX_MDIO-
3	RX_MDIO+	4	MDIO+
5	MDIO-	6	RX_MDIO-
7	MDIO3+	8	MDIO3-
9	N/C	10	N/C (Key)



CFD1 : Compact Flash Disk socket (share with IDE1) (28)

FAN1: System Fan Power Connector (30)

FAN1 is a 3-pin headers for the CPU fan. The fan must be a +5V fan.

Pin Description

1	N/C
2	+5V
3	GND



PC104+: PC/104+ PCI Bus Expansion Slot (31)

CONA1: PC/104 ISA bus Slot (19)